

*supports voice*

greater reach

*higher data rates*

interoperability

*advanced diagnostics*

rate adaptive

*user-friendly*

faster start-up

*power management*

all-digital mode

**ADSL2 AND ADSL2+**  
The New ADSL Standards  
Revision 3



**A W A R E**



The year 2004 brings the first large scale commercial deployments of ITU G.992 compliant ADSL2 and ADSL2+ equipment, culminating several years of work across the DSL industry to introduce these vastly improved standards. Back in July 2002, the ITU completed the ADSL2 standards; in January 2003, the completion of ADSL2+ brought unprecedented data rates of 24 Mbps to the ADSL2 standards. And in October 2003, Reach Extended ADSL2 joined the ADSL2 family, delivering bandwidth on phone lines as long as 22,000 feet. Collectively, the ADSL2 family of standards delivers significant improvements in performance as well as valuable new features that will undoubtedly accelerate the growth of the worldwide DSL subscribership, now well over 60 million households.

Carriers, service providers, and subscribers played a key role in the completion of ADSL2, having provided valuable feedback from the field that the ITU in turn incorporated into the standards in the form of new features and performance improvements. As a result, ADSL2 is more user-friendly to subscribers and more profitable to carriers, and promises to continue the great success of ADSL through the rest of the decade.

ADSL2 (ITU G.992.3 and G.992.4) adds new features and functionality targeted at improving performance and interoperability, and adds support for new applications, services, and deployment scenarios. Among the changes are improvements in data rate and reach performance, rate adaptation, diagnostics, and stand-by mode.

ADSL2+ (ITU G.992.5) doubles the bandwidth used for downstream data transmission, effectively doubling the maximum downstream data rates, and achieving rates of 20 Mbps on phone lines as long as 5,000 feet. ADSL2+ solutions will most commonly be multimodal, interoperating with ADSL and ADSL2, as well as with ADSL2+ chipsets. More detail about ADSL2+ is included later in this paper.

ADSL2+ will enable service providers to evolve their networks to support advanced services such as video in a flexible way, with a singular solution for both short-loop and long-loop applications. It will include all the feature and performance benefits of ADSL2 while maintaining the capability to interoperate with legacy equipment. As such, carriers will be able to overlay new, advanced technologies without having to “forklift-upgrade” existing equipment, allowing for a gradual transition to advanced services. Figure 1 provides a summary of ADSL technology standards.

**FIGURE 1: ADSL STANDARDS**

<b>FAMILY</b>	<b>DESCRIPTION</b>	<b>RATIFIED</b>
<b>ADSL</b>	<b>G.992.1 G.dmt</b>	<b>1999</b>
<b>ADSL</b>	<b>G.992.2 G.lite</b>	<b>1999</b>
<b>ADSL2</b>	<b>G.992.3 G.dmt.bis</b>	<b>2002</b>
<b>ADSL2</b>	<b>G.992.4 G.lite.bis</b>	<b>2002</b>
<b>ADSL2</b>	<b>G.992.5 ADSL2 PLUS</b>	<b>2003</b>
<b>ADSL2</b>	<b>G.992.3 Reach Extended</b>	<b>2003</b>

## RATE AND REACH IMPROVEMENTS

ADSL2 has been specifically designed to improve the rate and reach of ADSL largely by achieving better performance on long lines. ADSL2 accomplishes this by improving modulation efficiency, reducing framing overhead, achieving higher coding gain, improving the initialization state machine, and providing enhanced signal processing algorithms. As a result, ADSL2 mandates higher performance for all standard-compliant devices.

ADSL2 provides better modulation efficiency by mandating four-dimensional, 16-state trellis-coded and 1-bit quadrature amplitude modulation (QAM) constellations, which provide higher data rates on long lines where the signal-to-noise ratio (SNR) is low. In addition, receiver-determined tone reordering enables the receiver

to spread out the non-stationary noise due to AM radio interference to get better coding gain from the Viterbi decoder.

ADSL2 systems reduce framing overhead by providing a frame with a programmable number of overhead bits. Therefore, unlike the first-generation ADSL standards where the overhead bits per frame are fixed and consume 32 kbps of actual payload data, in the ADSL2 standard the overhead bits per frame can be programmed from 4 to 32 kbps.

In first-generation ADSL systems, on long lines where the data rate is low (e. g. 128 kbps), a fixed 32 kbps (or 25% of the total data rate) is allocated to overhead information. In ADSL2 systems, the overhead data rate can be reduced to 4 kbps, which provides an additional 28 kbps for payload data.

On long lines where data rates are lower, ADSL2 achieves higher coding gain from the Reed-Solomon (RS) code. This is due to improvements in the ADSL2 framers that improve flexibility and programmability in the construction of the RS codewords.

Additionally, the initialization state machine has numerous improvements that provide increased data rates in ADSL2 systems. Examples include:

- Power cutback capabilities at both ends of the line to reduce near-end echo and the overall crosstalk levels in the binder.
- Determination of the pilot tone location by the receiver in order to avoid channel nulls from bridged taps or narrow band interference from AM radio.
- Control of certain key initialization state lengths by the receiver and transmitter in order to allow optimum training of receiver and transmitter signal processing functions.
- Determination of the carriers used for initialization messages by the receiver in order to avoid channel nulls from bridged taps or narrow band interference from AM radio.
- Improvement in channel identification for training receiver time domain equalizer with spectral shaping during Channel Discovery and Transceiver Training phases of initialization.
- Tone blackout (disabling tones) during initialization to enable radio frequency interference (RFI) cancellation schemes.

**FIGURE 2:**  
ADSL2 SYSTEMS CAN DELIVER AN IMPROVEMENT IN REACH OF ABOUT 600 FEET.

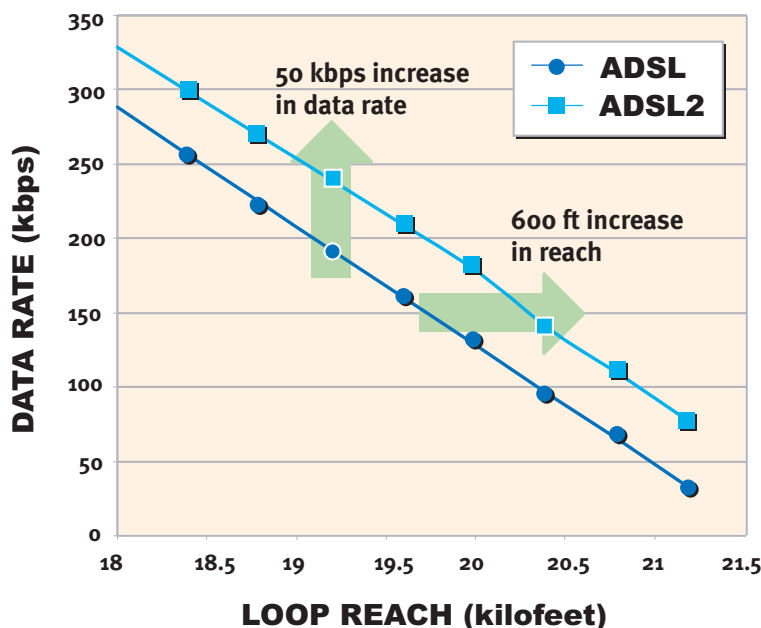

Figure 2 shows the rate and reach of ADSL2 as compared to the first-generation ADSL standard. On longer phone lines, ADSL2 will provide a data rate increase of 50 kbps; a significant increase for those customers who need it most.

This data rate increase results in an increase in reach of about 600 feet, which translates to an increase in coverage area of about 6%, or 2.5 square miles.

## DIAGNOSTICS

Determining the cause of problems in consumer ADSL service has at times been a challenging obstacle in ADSL deployments. To tackle the problem, ADSL2 transceivers have been enhanced with extensive diagnostic capabilities. These diagnostic capabilities provide tools for trouble resolution during and after installation, performance monitoring while in service, and upgrade qualification.

In order to diagnose and fix problems, ADSL2 transceivers provide for measurements of line noise, loop attenuation, and signal-to-noise ratio (SNR) at both ends of the line. These measurements can be collected using a special diagnostic testing mode even when line quality is too poor to actually complete the ADSL connection.

Additionally, ADSL2 includes real-time performance monitoring capabilities that provide information on line quality and noise conditions at both ends of the line. This information is interpreted by software and then used by the service provider to monitor the quality of the ADSL connection and prevent future service failures. It can also be used to determine if a customer can be offered higher data rate services.

**FIGURE 3: ADSL2'S L2 POWER MODE ALLOWS A BROADBAND MODEM TO QUICKLY MOVE FROM L2 TO L0 OPERATION AND BACK WITHOUT BIT ERRORS.**

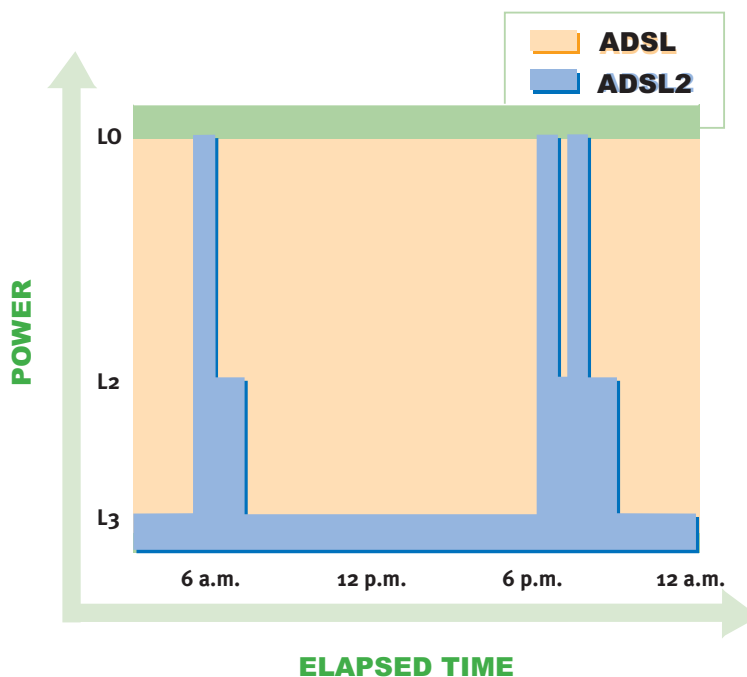

## POWER ENHANCEMENTS

First-generation ADSL transceivers operate in full-power mode day and night, even when not in use. With several millions of deployed ADSL modems, a significant amount of electricity can be saved if the modems engage in a stand-by/sleep mode just like computers. This would also save power for ADSL transceivers operating in small remote units and digital loop carrier (DLC) cabinets that operate under very strict heat dissipation requirements (Figure 3). To address these concerns, the ADSL2 standard brings in two power management modes that help reduce overall power consumption while maintaining ADSL's "always-on" functionality for the user. These modes include:

- **L2 low-power mode**  
This mode enables statistical powers savings at the ADSL transceiver unit in the central office (ATU-C) by rapidly entering and exiting low power mode based on Internet traffic running over the ADSL connection.
- **L3 low-power mode**  
This mode enables overall power savings at both the ATU-C and the remote ADSL transceiver unit (ATU-R) by entering into sleep mode when the connection is not being used for extended periods of time.

The L2 power mode is one of the most important innovations of the ADSL2 standard. ADSL2 transceivers can enter and exit the L2 low power mode based on the Internet traffic over the ADSL connection. When large files are being downloaded, ADSL2 operates in full power mode (called

“L0” power mode) in order to maximize the download speed. When Internet traffic decreases, such as when a user is reading a long text page, ADSL2 systems can transition into L2 low power mode, in which the data rate is significantly decreased and overall power consumption is reduced.

While in L2, the ADSL2 system can instantly re-enter L0 and increase to the maximum data rate as soon the user initiates a file download. The L2 entry/exit mechanisms and resulting data rate adaptations are accomplished without any service interruption or even a single bit error, and as such, are not noticed by the user.

The L3 power mode is a sleep mode where no traffic can be communicated over the ADSL connection when the user is not on-line. When the user returns to go on-line the ADSL transceivers require approximately three seconds to re-initialize and enter into steady-state communication mode.

### RATE ADAPTATION

Telephone wires are bundled together in multi-pair binders containing 25 or more twisted wire pairs. As a result, electrical signals from one pair can electromagnetically couple onto adjacent pairs in the binder (Figure 4). This phenomenon is known as “crosstalk” and can impede ADSL data rate performance.

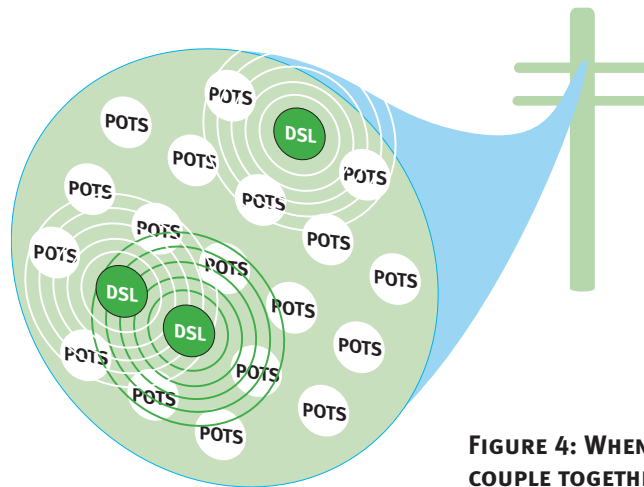

**FIGURE 4: WHEN ADJACENT PAIRS COUPLE TOGETHER THEY CAN CAUSE CROSSTALK, POTENTIALLY FORCING THE ADSL SYSTEM TO DROP A CONNECTION.**

As a result, changes in the crosstalk levels in the binder can cause an ADSL system to drop the connection. Crosstalk is just one reason that ADSL lines drop connections. Others include AM radio disturbers, temperature changes, and water in the binder.

ADSL2 addresses these problems by seamlessly adapting the data rate in real-time. This new innovation, called seamless rate adaptation (SRA), enables the ADSL2 system to change the data rate of the connection while in operation without any service interruption or bit errors. ADSL2 simply detects changes in the channel conditions – for example, a local AM radio station turning off its transmitter for the evening – and adapts the data rate to the new channel condition transparently to the user.

SRA is based on the decoupling of the modulation layer and the framing layer in ADSL2 systems. This decoupling enables the modulation layer to change the transmission data rate parameters without modifying parameters in the framing layer which would cause the modems to lose frame synchronization resulting in uncorrectable bit errors or system restart. SRA uses the sophisticated online reconfiguration (OLR) procedures of ADSL2 systems to seamlessly change the data rate of the connection. The protocol used for SRA works as follows:

1. The receiver monitors the SNR of the channel and determines that a data rate change is necessary to compensate for changes in channel conditions.

2. The receiver sends a message to the transmitter to initiate a change in data rate. This message contains all necessary transmission parameters for transmitting at the new data rate. These parameters include the number of bits modulated and transmit power on each subchannel in ADSL multicarrier system.
3. The transmitter sends a “Sync Flag” signal which is used as a marker to designate the exact time at which the new data rate and transmission parameters are to be used.
4. The Sync Flag signal is detected by the receiver and both transmitter and receiver seamlessly and transparently transition to the data rate.

### BONDING FOR HIGHER DATA RATES

A common requirement among carriers is the ability to provide different service level agreements (SLAs) to different customers. Data rates to homes and businesses can be significantly increased by bonding multiple phone lines together. To enable bonding, the ADSL2 standards support the ATM Forum’s inverse multiplexing for ATM (IMA) standard (af-phy-0086.001) developed for traditional ATM architectures. Through IMA, ADSL2 chipsets can bind two or more copper pairs in an ADSL link. The result is far greater flexibility with downstream data rates (Figure 5). The IMA standard specifies a new sublayer that resides between the ADSL physical layer (PHY) and the ATM layer. At the transmitter side, this sublayer, called the IMA sublayer, takes in a single ATM stream from the ATM layer and distributes this stream to multiple

FIGURE 5: SEVERAL PHONE LINES CAN BE BONDED TO MULTIPLY DATA RATES.

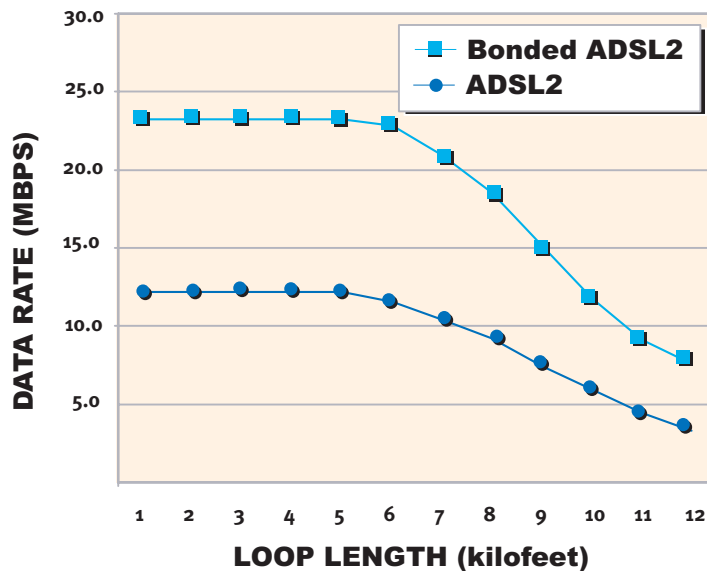

ADSL PHYs. At the receiver side, the IMA sublayer takes in ATM cells from multiple ADSL PHYs and reconstructs the original ATM stream.

The IMA sublayer specifies IMA framing, protocols and management functions that are used to perform these operations when the PHYs are lossy (bit errors), asynchronous, and have different delays. In order to work under these conditions, the IMA standard also requires modifications to some of the standard ADSL PHY functions such as the discarding of idle cells and errored cells at the receiver. ADSL2 includes an IMA operation mode to provide the necessary PHY modifications for IMA to work in combination with ADSL.

### CHANNELIZATION AND VOICE OVER DSL

ADSL2 provides the ability to split the bandwidth into different channels with different link characteristics for different applications. For example, ADSL2 enables simultaneous support of a voice application, which might have low latency but a higher error rate requirement, and a data application, which might have high latency but lower error rate requirement.

ADSL2's channelization capability also provides support for Channelized Voice over DSL (CVoDSL), a method to transport derived lines of TDM voice traffic transparently over DSL bandwidths. CVoDSL is unique among voice over DSL solutions in that it transports voice within the physical layer, allowing transport of derived voice channels over DSL bandwidth while maintaining both POTS and high-speed Internet access. The result is a simple, flexible, cost-effective method to enable next-generation equipment with derived voice functionality.

CVoDSL reserves 64 kbps "channels" of DSL bandwidth (Figure 6) to deliver PCM DS0s from the DSL modem to the remote terminal or central office, much like regular POTS (plain old telephone service). The access equipment then transmits the voice DS0s directly to the circuit switch via PCM. This approach elimi-

**FIGURE 6: CVoDSL DEDICATES CHANNELS OF PHYSICAL LAYER BANDWIDTH TO CARRY TDM VOICE LINES.**

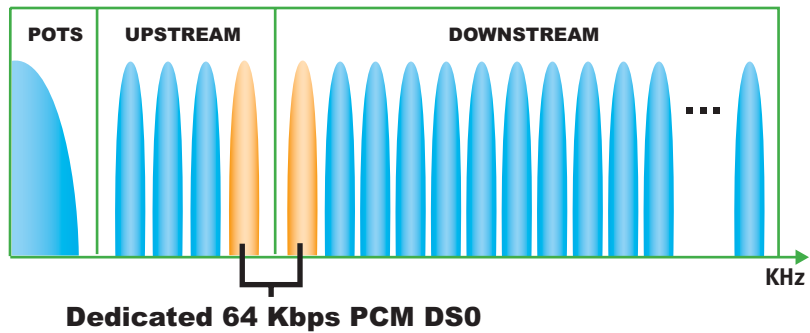

ates the need for packetization of voice traffic over the phone line into higher protocols such as ATM and IP (Figure 7). Multiple voice lines can be active simultaneously; given typical constraints on ADSL upstream bandwidth, four uncompressed voice lines might be a reasonable maximum, using an upstream bandwidth of 256 kbps.

**FIGURE 7: CVoDSL DOES NOT PACKETIZE VOICE DATA, AS VoIP AND VoATM DO.**

**CVoDSL vs. VoATM and VoIP**

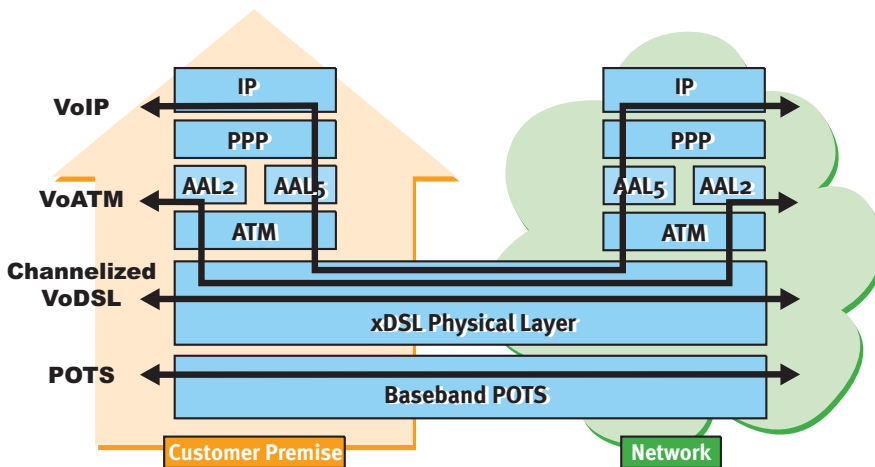

**SOME ADDITIONAL BENEFITS**

ADSL2 provides several other important features in addition to the benefits described here:

**Improved Interoperability:**

Clarifications and additions to the initialization state machine improve interoperability and provide better performance when connecting ADSL transceivers from different chip suppliers.

**Fast startup:** ADSL2 provides a fast startup mode that reduces initialization time from more than 10 seconds (as is required for ADSL) to less than 3 seconds.

**All-Digital Mode:** ADSL2 enables an optional mode that allows for transmission of ADSL data in the voice bandwidth, adding 256 kbps of upstream data rate. This is an attractive option for businesses that have their voice and data services on different phone lines, and value the extra upstream bandwidth.

### Support of Packet-Based Services:

ADSL2 includes a packet mode transmission trans-convergence layer (PTM-TC) that enables packet-based service (such as Ethernet) to be transported over ADSL2.

### ADSL2+

ADSL2+ reached consent at the ITU in January 2003, joining the ADSL2 standards family as G.992.5. The ADSL2+ recommendation doubles the downstream bandwidth, thereby increasing the downstream data rate on telephone lines shorter than about 5,000 feet.

While the first two members of the ADSL2 standards family specify a downstream frequency band up to 1.1 MHz and 552 kHz respectively, ADSL2+ specifies a downstream frequency up to 2.2 MHz (Figure 8). The result is a significant increase in data rates on shorter phone lines (Figure 9).

ADSL2+ can also be used to reduce crosstalk. ADSL2+ provides the capability to use only tones between 1.1 MHz and 2.2 MHz by masking the downstream frequencies below 1.1 MHz. This can be particularly useful when ADSL services from both the central office (CO) and a remote terminal (RT) are present in the same binder as they approach customers' homes (Figure 10). The crosstalk from the ADSL services from the RT onto the lines from the CO can significantly impair data rates on the line from the CO.

FIGURE 8: ADSL2+ DOUBLES THE BANDWIDTH USED TO CARRY DATA.

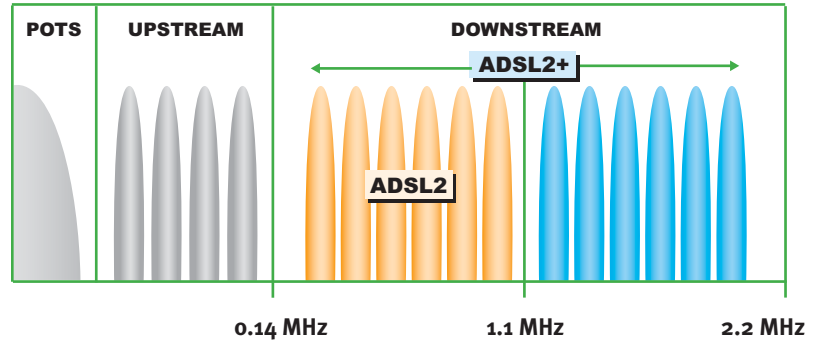

FIGURE 9: ADSL2+ DOUBLES THE MAXIMUM DATA RATE.

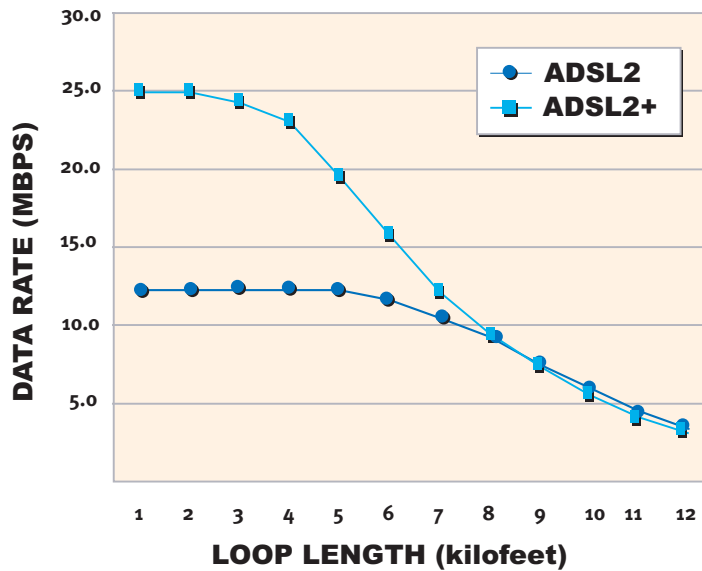
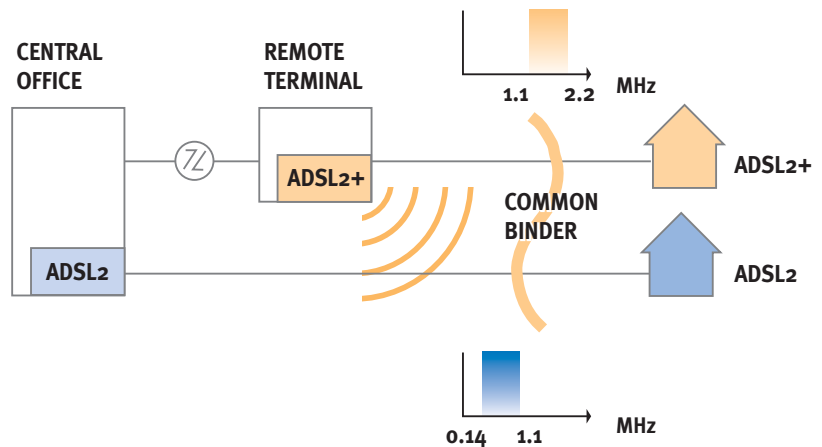

FIGURE 10: ADSL2+ CAN BE USED TO REDUCE CROSSTALK.



ADSL2+ can correct this problem by using frequencies below 1.1 MHz from the central office to the remote terminal, and frequencies between 1.1 MHz and 2.2 MHz from the remote terminal to the customer premise. This will eliminate most of the crosstalk between the services and preserve data rates on the line from the central office.

## ADSL ANNEXES

ADSL standards include annexes that specify ADSL operation for particular applications and regions around the world. Several annexes associated with the first ADSL standard will also apply to the ADSL2 standards family, including ADSL2+. Generally speaking, the annexes specify subcarriers (or tones) and their associated transmission power levels used for upstream and downstream transmission. Figure 11 summarizes the ADSL annexes.

### Annexes A and B

Annex A specifies operation of ADSL using bandwidths higher than POTS, so as to preserve POTS operation. It is the most common application of ADSL, used throughout North America and much of Europe and Asia. Annex B works similarly to Annex A, though it is designed to work on phone lines enabled with ISDN instead of POTS, which is common in Germany and a few other regions. Both Annex A and Annex B have been extended to apply to ADSL2 and ADSL2+.

### ADSL Annexes C and I

Annex C of the original ADSL standards (G.992.1, G.992.2) is designed specifically for use in Japan. It allows ADSL to operate in such a way so as not to interfere with Japan's special "ping-pong" version of ISDN, or TCM-ISDN.

New features of Annex C were consented by the ITU in January 2003 to improve ADSL technologies used in Japan. A new annex to complement the original ADSL Annex C called "Annex I" doubles the downstream of the original Annex C, much like ADSL2+ doubles the downstream of ADSL2. This particular Annex I will not apply to ADSL2. Note that there are two "Annex I"s; one for the original ADSL, and one for ADSL2/ADSL2+. There is also a separate amendment to ADSL Annex C that improves its reach.

FIGURE 11: ADSL STANDARD ANNEXES

ANNEX	ENVIRONMENT	USE OF TONES					APPLICABLE TO:		
		1-5	6-31	32-64	65-255	256-512	ADSL G.992.1	ADSL2 G.992.3	ADSL2+ G.992.5
A	POTS	POTS	UP	DOWN	DOWN	DOWN*	YES	YES	YES
B	ISDN	ISDN	ISDN	UP	DOWN	DOWN*	YES	YES	YES
C	TCM-ISDN	POTS	UP	DOWN	DOWN	N/A	YES	YES	YES
I (ADSL)	TCM-ISDN	POTS	UP	DOWN	DOWN	DOWN	YES	NO	NO
I (ADSL2)	POTS	UP	UP	DOWN	DOWN	DOWN*	NO	YES	YES
J	ISDN	UP	UP	UP	DOWN	DOWN*	NO	YES	YES
L (RE-ADSL2)	POTS	POTS	UP**	DOWN**	DOWN**	N/A	NO	YES	NO
M (ADSL2+)	POTS	UP	UP	UP	DOWN	DOWN*	NO	YES	YES

Use of tones applies to the non-overlapped PSD masks only  
 \* ADSL2+ only  
 \*\* Not all tones are used

## ADSL2 Annexes I and J

Annexes I and J for ADSL2 are for all-digital operation, meaning that traditional voice bandwidths are used by DSL to transmit digital data instead of for traditional voice. Annexes I and J are specified for all-digital operation in POTS and ISDN environments, respectively. Note that this particular Annex I—applicable only to ADSL2 and ADSL2+—is different from the Annex I that amends the original ADSL Annex C standard for use in Japan. Annex I has been approved for ADSL2 and ADSL2+; Annex J has been approved for ADSL2 and has not yet been approved for ADSL2+.

### ADSL2 (G.992.3) Annex L: Reach Extended ADSL2 (RE-ADSL2)

Reach-Extended ADSL2 systems provide increased performance on long lines under various crosstalk conditions. The increase in transmit PSD levels result in increased data rates, which are achieved even though the overall transmit bandwidth is less than Annex A ADSL systems. This is primarily because the higher frequency spectrum is not usable on long lines due to the large channel attenuation. As a result, RE-ADSL2 systems provide an increase in data rate on shorter lines (where the high frequency spectrum is good) as compared to Annex A systems, even though they use less overall bandwidth.

FIGURE 12: REACH EXTENDED ADSL2 (RE-ADSL2) REACH IMPROVEMENT

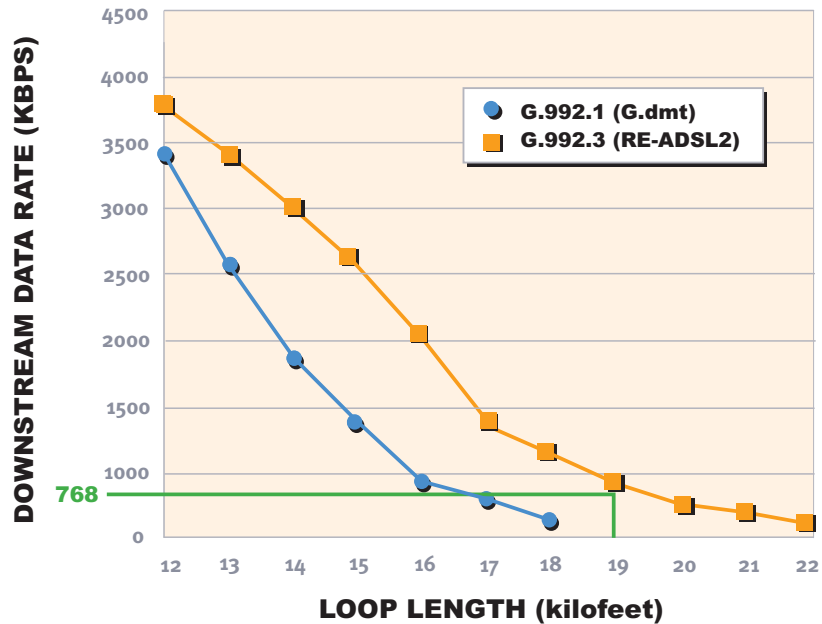

The Reach-Extended ADSL2 system was evaluated under a large number of crosstalk conditions and loop topologies [1,2,3]. Figure 12 compares the downstream data rate performance of conventional ADSL systems based on G.992.1 (G.dmt) and RE-ADSL2 systems based on G.992.3. The crosstalk environment for this

test case is white noise injected at the RT. Under these test conditions RE-ADSL2 extends a 768 Kbps downstream service approximately 3,000 feet to 19,000 feet. As a result, the coverage area for this service increases about 37%. (Figure 13)

FIGURE 13: RE-ADSL2 EXTENDS COVERAGE AREA OF 768 KBPS SERVICE APPROXIMATELY 37%

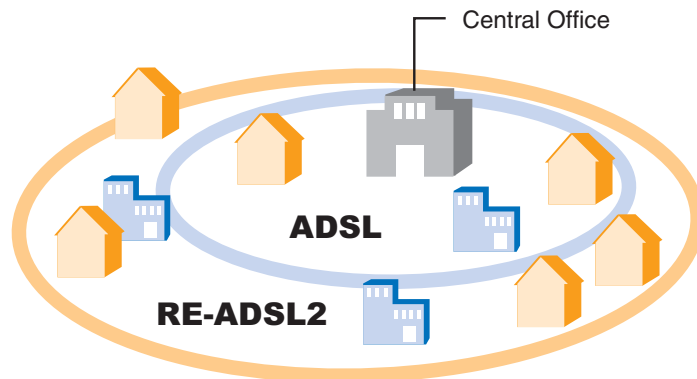

## ANNEX M

A new Annex M (formerly known as Annex L in G.992.5) for G.992.3 (ADSL2) and G.992.5 (ADSL2+) was consented at the October 2003 ITU meeting in Geneva. Annex M contains PSD Masks for new ADSL2 service over POTS that increases the upstream data rates by doubling the number of US tones to 64. As a result, Annex M provides higher upload speeds for users by doubling the upstream data rate (when compared to Annex A) under certain loop and noise conditions.

## ANNEX SUMMARY

Figure 14 shows the performance of each of the ADSL and ADSL2 standards and annexes on given loop lengths. This illustrates the improvement of rate and reach that ADSL2, ADSL2+, and RE-ADSL2 offer when compared to ADSL and each other.

**FIGURE 15:**  
**EXAMPLE OF AUTOMODE FUNCTION**

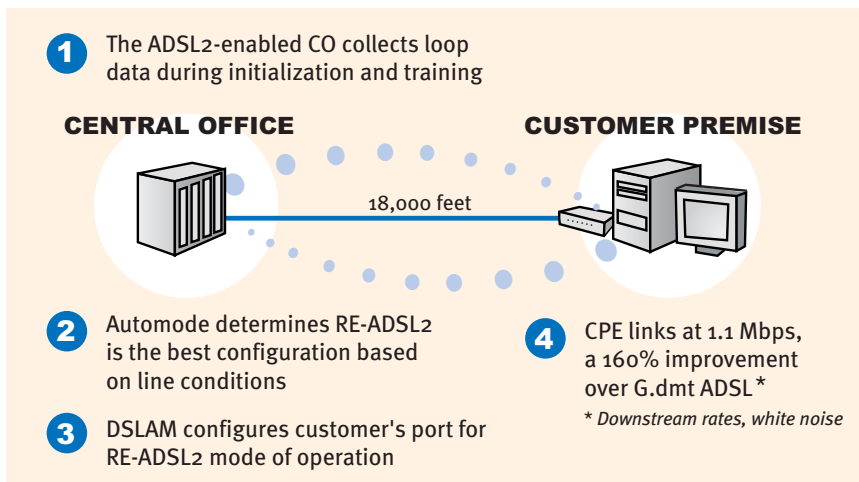

**FIGURE 14: RATE & REACH PERFORMANCE OF ADSL AND ADSL2 STANDARDS**

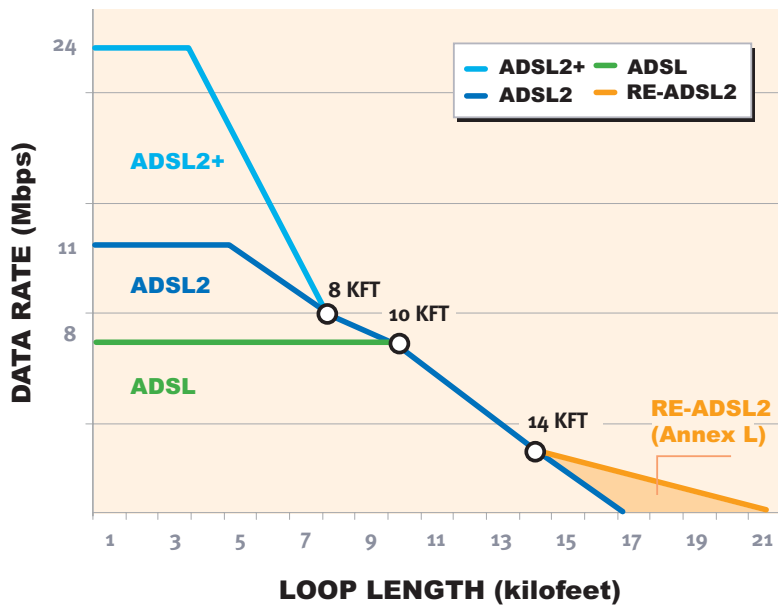

## AUTOMODE

A new capability called “Automode” was added to the latest revision of the ADSL2 family of standards. Automode enables service providers to offer their customers the best and most appropriate level of service for their location. Automode uses the information gathered during initialization and training between the ADSL2 CO and ADSL2 CPE to select the best mode of operation for a given loop and noise condition. (Figure 15)

## CONCLUSION

Carriers and subscribers have played a key role in the completion of ADSL2, having provided valuable feedback from the field that the ITU in turn incorporated into the standards in the form of new features and performance improvements. As a result, ADSL2 will be more user-friendly to subscribers and more profitable to carriers, and promises to continue the great success of ADSL through the rest of the decade.

Please contact Aware at [marketing@aware.com](mailto:marketing@aware.com) with questions or comments about this white paper.

**AWARE, INC.**  
**40 MIDDLESEX TURNPIKE**  
**BEDFORD, MA 01730-1432**  
**T 781-276-4000 F 781-276-4001**  
**E [MARKETING@AWARE.COM](mailto:MARKETING@AWARE.COM)**  
**W [HTTP://WWW.AWARE.COM](http://WWW.AWARE.COM)**

## REFERENCES

- [1] ITU-T Document, OJ-212, "Range Extended ADSL: Proposed Evaluation Conditions"  
Osaka, Japan, October 21-25, 2002
- [2] ITU-T Document D587, "Performance Numbers for Range Extended ADSL" Geneva, January 20-31, 2003
- [3] ITU-T Document D588, "More results for Range Extended ADSL"  
Geneva, January 20-31, 2003
- [4] ITU-T Document TD59, "Amendment 1 to Annex J and new Annex L and M to Recommendation G.992.3"  
Geneva, October 21-31, 2003

## ABOUT AWARE

Aware, Inc. is a worldwide leader in the development and marketing of semiconductor intellectual property (IP) for broadband communications. Our focus is DSL technology which enables high-speed data, voice and video over telephone lines. We deliver complete IP platforms which our customers can easily integrate into system-on-chip solutions. Our technology offerings consist of complete RTL, software, and reference designs. Aware is headquartered in Bedford, Massachusetts, and has approximately 125 employees. Aware is a publicly traded company on the NASDAQ Stock Exchange (symbol: AWRE).



**A W A R E**

### 05.05 REV. 3.0

Copyright © 2006 Aware, Inc. All Rights Reserved. No part of this publication may be reproduced, stored in a retrieval system, or transmitted in any form by any means, electronic, mechanical photocopying, recording, or otherwise without the prior written permission of Aware, Inc.

This document is for information purposes only and is subject to change without notice. Aware, Inc. assumes no responsibility for the accuracy of the information. AWARE MAKES NO WARRANTIES, EXPRESS OR IMPLIED, IN THIS DOCUMENT. "Aware" is a registered trademark of Aware, Inc. Other company and brand, product and service names are trademarks, service marks, registered trademarks or registered service marks of their respective holders.